



INSTALLATION INSTRUCTIONS PMP SERIES THREE-PHASE MONITOR RELAYS

July 2022

901-0000-358

DANGER!



Potentially hazardous voltages are present. Electrical shock can cause death or serious injury. Installation should be done by qualified personnel following all National, State & Local Codes.



BE SURE TO REMOVE ALL POWER SUPPLYING THIS EQUIPMENT BEFORE CONNECTING OR DISCONNECTING WIRING. READ INSTRUCTIONS BEFORE INSTALLING OR OPERATING THIS DEVICE. KEEP FOR FUTURE REFERENCE.

Installation and Wiring

1. Mount the appropriate 8 pin octal socket in a suitable enclosure. **NOTE: A 600V-rated socket such as the Macromatic 70169-D must be used with these products on applications greater than 300V (PMPU-FA12X requires SD12-PC 600V socket).** When making connections to the socket, **make sure to match the terminal numbers on the socket to the ones shown on the wiring diagram (the wiring diagram on the relay is the view looking towards the bottom of the relay vs. the top of the socket).** Use one or two #12-22 solid or stranded copper or copper-clad aluminum conductors with terminals on the above Macromatic sockets — a terminal tightening torque of 12 in-lbs should be used.

2. Set the VOLTAGE LINE-LINE knob to the actual three-phase line-to-line voltage. The Voltage Line-Line knob on the PMPU, PMPU-X, PMPU-FA8, PMPU-FA8X & PMPU-FA12X has two ranges (see right): 190-250V on the low voltage scale and 380-500V on the high voltage scale. The unit auto senses the three-phase line-line voltage when applied and automatically selects one of the two ranges. The PMP120 models have a single adjustable range of 102-138V and the PMP575 models have a single adjustable range of 460-600V.

3. (For PMPU-FA8, PMPU-FA8X & PMPU-FA12X, skip to Step 4)

Set initial settings on the UNDERVOLTAGE TRIP, TRIP DELAY and RESTART DELAY knobs to minimum. Set initial setting on the UNBALANCE knob to maximum.

4. Connect the three-phase line-line voltage to terminals 3, 4 and 5 (1, 3 and 5 on PMPU-FA12X). See Wiring Diagram on the side of the relay or on the back of this sheet. A connection to the neutral or ground is not required in Wye systems. **DO NOT** connect output wires to terminals until later (Step 13).

5. (For PMPU-X, PMP120-X, PMP575-X, PMPU-FA8X & PMPU-FA12X, skip to Step 6)

RESET: As standard, the PMP Series relays are in the Automatic Reset mode, which means they will automatically reset once the fault has been corrected. However, they can be set up in the Manual Reset mode by connecting an external N.C. switch across terminals 6 and 7. Upon application of three-phase voltage, the PMP Series will go into Manual Reset mode if it recognizes a closure across terminals 6 and 7. After a fault clears, the relay will not reset until the N.C. switch is opened. **NOTE:** When the unit is in the Manual Reset mode, the N.C. switch must be opened after each Power-up to reset the relay and resume normal operation. **NOTE:** This unit can only be set back to Automatic Reset mode from Manual Reset mode by removing three-phase voltage, removing the N.C. switch across terminals 6 and 7, and reapplying the three-phase voltage.

6. Plug the three-phase monitor relay into the socket, making sure the key on the center post is in the proper orientation before insertion. **If the relay must be removed from the socket, do NOT rock the relay back and forth excessively—the center post could be damaged.**

7. Apply three-phase voltage. The LED indicator should initially flash GREEN if in the Automatic Reset mode while the relay goes through its start-up delay or waiting for an external switch to be operated if in the Manual Reset mode and then illuminate solid GREEN (Manual Reset mode does not apply to PMPU-X, PMP120-X, PMP575-X, PMPU-FA8X or PMPU-FA12X). If the LED turns RED solid or flashing, a fault condition exists and must be corrected. **Use the LED Status Table at right or the Troubleshooting Guide on back to determine exact cause of fault.** Make required corrections.

Settings

8. REMOVE THREE-PHASE VOLTAGE for Steps 9-13 (For PMPU-FA8, PMPU-FA8X & PMPU-FA12X, REMOVE THREE-PHASE VOLTAGE and skip to Step 13).

9. Set the RESTART DELAY knob. This setting should be the time period required after a fault has been cleared before the relay should automatically energize. **NOTE:** this value is ignored when in the Manual Reset mode (see Step 5).

10. Set the UNDERVOLTAGE TRIP knob between 80 and 95% of the line-line voltage setting. This value should be the same as the minimum operating voltage for the equipment to be adequately protected.

11. Set the TRIP DELAY knob. This is the maximum time period that an unbalance, undervoltage or overvoltage condition should be allowed to last. Too short a setting will cause nuisance tripping if there are momentary changes in the three-phase voltage. Too long a setting could cause damage to the equipment. Note that the setting should be at least slightly longer than the time a three-phase motor is drawing its inrush or startup current. This will avoid nuisance tripping caused by the starting current.

12. Set the UNBALANCE knob. This setting should be the maximum allowable unbalance in phase voltage that the three-phase system can tolerate. Too low of a setting can cause nuisance tripping. Too high of a setting may not adequately protect the system.

13. Connect the output terminal wires to terminals 1, 2 and 8 (terminals 1, 2, 6, 7 and 8 for PMPU-X, PMP120-X, PMP575-X, PMPU-FA8X and terminals 7-12 on PMPU-FA12X). See Wiring Diagram on the side of the relay or below.

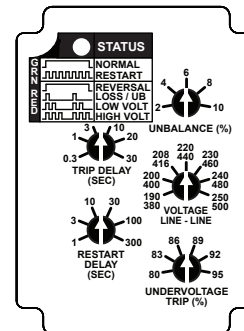

PMPU
190-500V

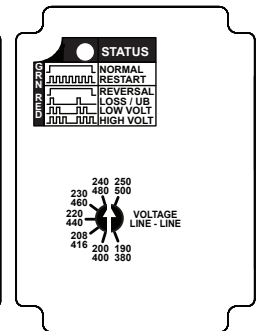

PMPU-FA8,
PMPU-FA8X &
PMPU-FA12X
190-500V

	LED STATUS	STATUS
GREEN		NORMAL (RELAY ON)
		RESTART (DELAY)
RED		REVERSAL
		LOSS/UB (UNBALANCE)
		LOW VOLT (UNDERVOLTAGE)
		HIGH VOLT (OVERVOLTAGE)



INSTALLATION INSTRUCTIONS

PMP SERIES

THREE-PHASE MONITOR RELAYS



Operation

14. When all connections are made, apply three-phase line-line voltage. The LED indicator should initially flash GREEN while the relay goes through its restart delay or waiting for an external switch to be operated if in the Manual Reset mode (*all, but PMPU-X, PMP120-X, PMP575-X, PMPU-FA8X & PMPU-FA12X, which is auto-reset only*) and then illuminate solid GREEN when all voltage conditions are correct.
15. If the LED does not illuminate solid GREEN during regular operation, a fault condition has occurred. REMOVE THREE-PHASE VOLTAGE, and check for proper phase rotation, presence of all three phases, and low or high voltage conditions. **Use the LED Status Table on the first page or the Troubleshooting Guide below to determine exact cause of fault.** Correct if necessary. Re-energization is automatic upon correction of the fault condition unless using MANUAL RESET (*all, but PMPU-X, PMP120-X, PMP575-X, PMPU-FA8X & PMPU-FA12X, which are auto-reset only*) which requires opening the N.C. switch across terminals 6 and 7 to reset the unit (see Step 5).

Troubleshooting

If the unit fails to operate properly, check that all connections are correct per the appropriate wiring diagram on the product. Check Troubleshooting table below. If problems continue, contact Macromatic at 800-238-7474 or e-mail tech-support@macromatic.com for assistance.

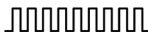
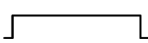
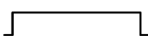
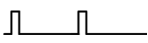
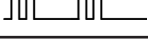
Troubleshooting Guide

LED STATUS	SITUATION	SOLUTION
GREEN 	Motor is not starting	Either (a) the relay is going through its POWER-UP/RESTART delay and will energize the output contacts when completed; or (b) the relay is in the Manual Reset mode and waiting for an external switch to be operated before energizing the output contacts (<i>all, but PMPU-X, PMP120X, PMP575-X, PMPU-FA8X & PMPU-FA12X, which are auto-reset only</i>).
GREEN 	Motor is not starting	The relay is in the run mode and working properly. Either another control device is preventing the motor from starting or all wiring should be checked.
NO INDICATION	Relay is not energized and/or motor is not running	Verify L1, L2 and L3 (A, B & C) are connected to correct terminals. Measure the three line-to-line voltages. If any of the voltages are below the specified minimum operation voltage, the relay does not have enough power to operate. Check to see why operating voltage is low and correct.
RED 	On power-up or with motor running	The relay is sensing a phase reversal or phase out-of-sequence (rotation) condition. REMOVE THREE-PHASE VOLTAGE and switch any two of the three line connections to the relay to ensure the phase sequence (rotation) is correct.
RED 	Either a phase loss or voltage unbalance condition	Make sure all three phases are present. Check for a blown fuse or a loose or broken wire. Measure all three line-line voltages and calculate the percent unbalance—compare to UNBALANCE knob setting. Determine why unbalanced condition exists and correct it.
RED 	Low voltage (Undervoltage)	Measure the three line-to-line voltages. If the average of these three voltages is below the UNDERVOLTAGE TRIP knob setting, the relay has tripped due to a low voltage
RED 	High voltage (Overvoltage)	Measure the three line-to-line voltages. If the average of these three voltages is > 10% of the VOLTAGE LINE-LINE knob setting, the relay has tripped due to a over voltage condition. Check for high voltage condition and correct it.

Typical Connections (For all, but PMPU-FA12X)

(For Load Side connection, contact Macromatic)

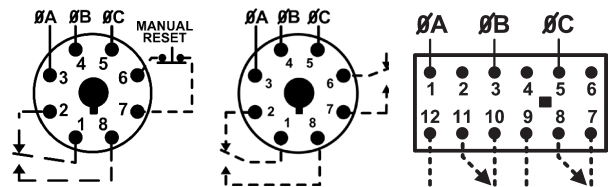
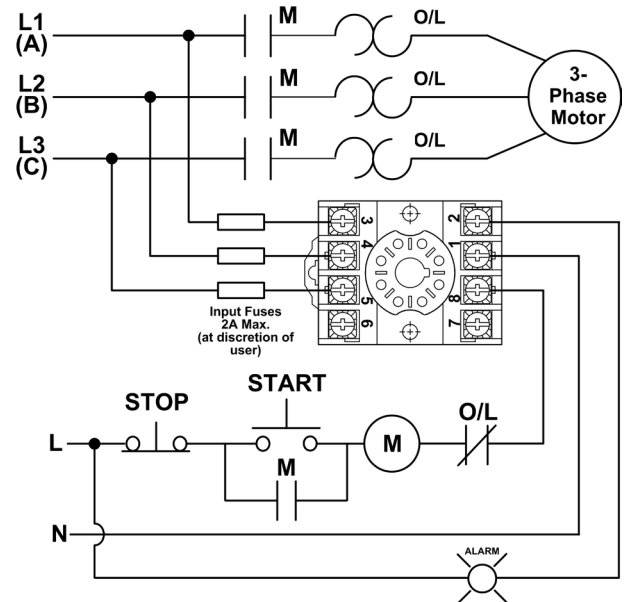

Diagram 104 All, but PMPU-X, PMP120-X, PMP575-X, PMPU-FA8X and PU-FA12X
Diagram 175 PMPU-X, PMP120-X, PMP575-X, PMPU-FA8X
Diagram 174 PMPU-FA12X

Warranty

All catalog-listed PMP Series products manufactured by Macromatic are warranted to be free from defects in workmanship or material under normal service and use for a period of five (5) years from date of manufacture.