



Better. By Design.

Water & Wastewater Solutions

Prevent Downtime and Extend Equipment life



Water & Wastewater Solutions

Macromatic relays and control products help municipalities maintain clean water for public health while preventing downtime and extending equipment life.

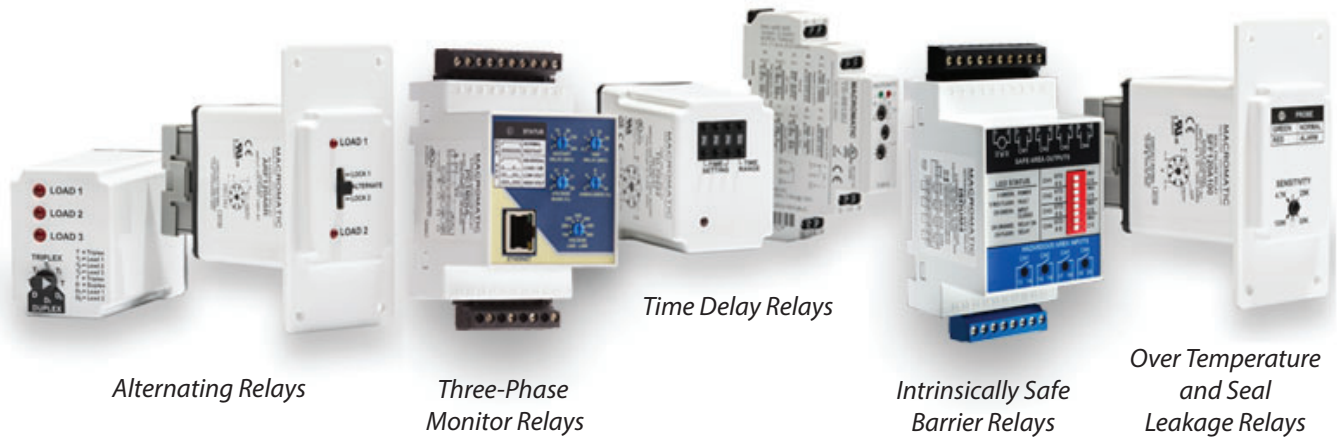

PREVENTING DOWNTIME AND EXTENDING EQUIPMENT LIFE

To protect the environment and provide safe water, municipalities rely on treatment plants, pumping stations, and lift stations. Miles of underground infrastructure supply, collect and treat water.

Reliable operations of lift stations are critical to move wastewater through the system. Failure can cause wastewater to backup into nearby homes and businesses, and to overflow into the surrounding environment.

Lift stations depend on industrial controls and relays to monitor and protect the pumps. The control system design is simple, ensuring dependable operation and easy maintenance for decades.

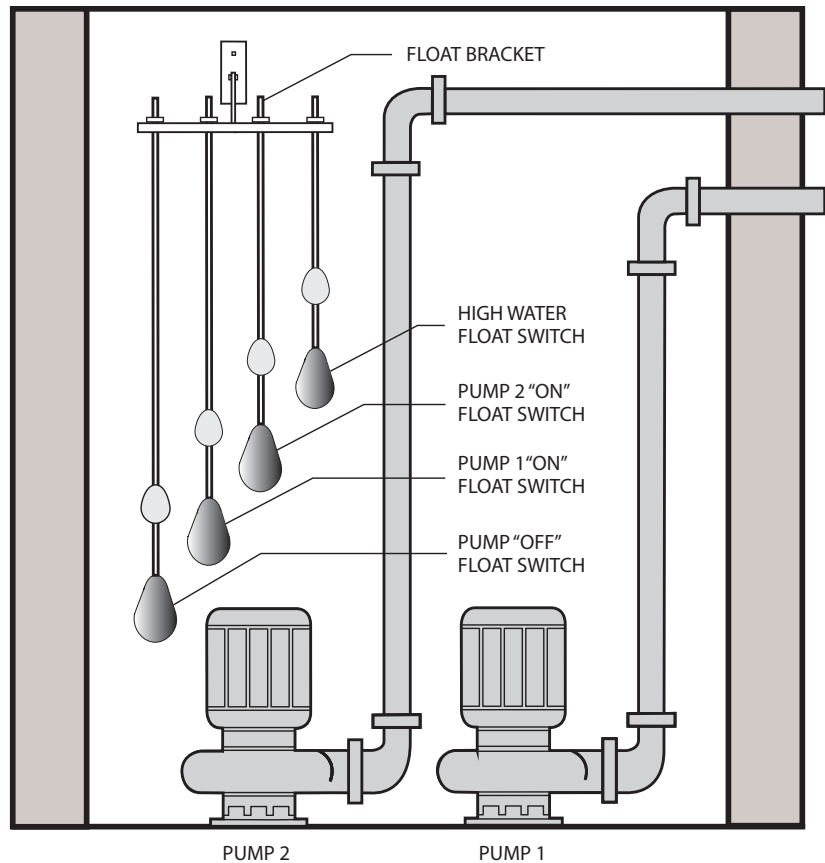

In a typical lift station, an idle standby pump is available in case the first unit fails. Macromatic Alternating Relays prevent deterioration of the idle unit by equalizing run time. The relays also respond to signals from float switches in the wet well to operate multiple loads simultaneously when additional capacity is needed.

TYPICAL CONTROL PANEL

Three-Phase Monitor Relays protect motors in lift stations and other water treatment systems against premature failure. The relays continuously monitor and detect voltage variations.

Time Delay Relays prevent the simultaneous start-up of multiple pumps in lift systems after a power outage. As a result, the circuit breakers will not trip when power is restored.

Alternating Relays equalize run time in multiple- pump systems to increase equipment life. The relays also engage multiple pumps if additional capacity is required.

Pump Seal Failure Relays protect submersible pumps by monitoring for over temperature and shaft seal leakage.

Intrinsically Safe Barrier Relays provide low-cost protection when controlling loads with input devices located in hazardous locations.

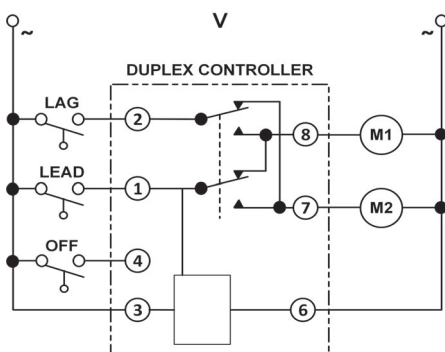
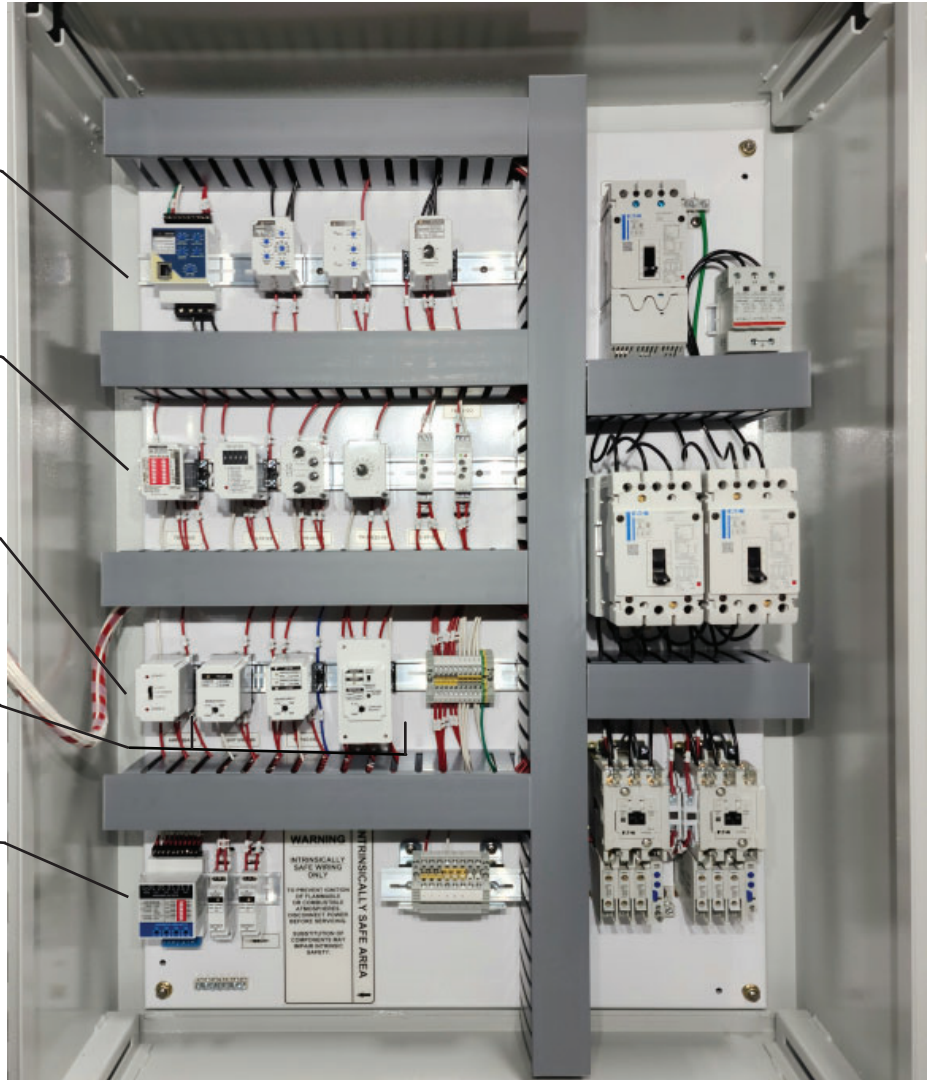

A Sequence On - Simultaneous Off (S.O.S.O.) operation with three float switch inputs protects against failures of both OFF and LEAD switches.

DUPLEX CONTROLLERS FOR S.O.S.O. OPERATION REDUCE PANEL COSTS

Many duplex pump applications require Sequence On - Simultaneous Off (S.O.S.O.) operation with three switch inputs and alternation of which pump is turned on first. The two loads are energized sequentially when the LEAD & LAG switches close but remain on together until the OFF switch is opened.

Macromatic ARP Series Duplex Controllers combine the function of alternating relay, control relay and auxiliary contacts in one plug-in unit. This reduces control panel cost by saving space, reducing the number of components and minimizing assembly labor.

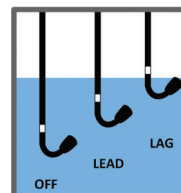
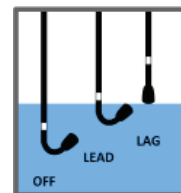
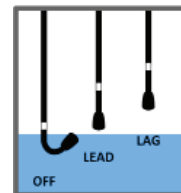

Water & Wastewater Solutions

TIME DELAY RELAYS PREVENT TRIPPING THE MAIN BREAKER

When power outages shut down the lift station system, water continues to flow into the well. The level controller then calls for both pumps to run. When power is restored, both contactors start in unison, and the inrush current can cause the main breakers to trip.

A Time Delay Relay provides a simple solution. An On-Delay function can delay the start-up of the second pump.

The instantaneous relay function is wired to the first motor starter, and the timed relay function is wired to the second motor starter. With that time delay set to 10 seconds, the lift station restarts only one pump, with the other pump starting ten seconds later. As a result, the circuit breakers will not trip when power is restored.



*TR-5 Series
Time Delay Relay*



*PC Series
Phase Monitor
With Communication*

PHASE MONITORS PREVENT EQUIPMENT DAMAGE

Three-Phase Monitor Relays protect motors in lift stations and other water treatment systems against premature failure. The relays continuously monitor and detect voltage variations.

The PC Series communicates voltage parameters via Modbus TCP. Real time alerts and historical fault data reduce downtime and service costs.

Remote monitoring can detect and alert support personnel of problems at remote installations. Control contacts can turn off equipment before damage occurs.

The PC Series is easy to incorporate with either DIN-rail or panel mounting, pluggable terminal blocks and embedded communications.



www.macromatic.com

800.238.7474

Your source for quality, innovative industrial control solutions

Macromatic Industrial Controls, Inc. designs and manufactures control, monitoring and protection products to manage your electrical processes and to protect your equipment from damaging fault conditions.

With a 47-year legacy of high-quality products and outstanding customer service, we continue to introduce innovative solutions that help our customers be more productive and efficient.

Our design and application experience makes it easy to find cost-effective advantages for your applications.



Better. By Design.

Macromatic Industrial Controls, Inc. • 2201 Corporate Drive • Waukesha, WI 53189
800.238.7474 • 262.781.3366 • sales@macromatic.com • www.macromatic.com